



BALLAST WATER TREATMENT SYSTEM

GI **En-Patrol™**

BWTS 既存船の設置工事の案内

日本語

PANASIA



CONTENTS

Introduction	04
Engineering	08
1) Pre-Engineering	08
2) Detail Engineering	11
Service	15
1) Project management	15
2) Supervision	16
設置工事事例	18
1) DOCK工事	
- Engine Room	20
- Engine Room & Pump Room	28
- On Deck	30
- Machinery Room	32
2) 航海中工事	
- Engine Room	36
3) 岸壁工事	
- Engine Room	42
• Worldwide Service Network	46

既存船の設置工事の範囲は、
お客様のニーズに合わせて
自由に選択できます。

EQUIPMENT SUPPLIER

- BWTS Equipment
- Commissioning
- Demonstration

Engineering Company

- Onboard Survey
- Basic Design
- Owner/ Class plan approval
- Interface with existing automation system

Design Company

- Installation drawing
- Manufacturing drawing

Outfitting Material Supplier

- Steel Structures
- Pipe Spools
- Cables
- Installation Materials

Installation Labor

- Pipe spools installation
- Laying & connection cables

Supervisor

- Schedule control
- Quality control
- Instruction to workers



BWTS 設置工事の契約の形態

CASE 1 (BWTS) 機器装置+工事監理

CASE 2 (BWTS) 機器装置+エンジニアリング+工事監理

CASE 3 (BWTS) 機器装置+エンジニアリング+設置資材
(配管、艀装、電気関係) の供給+工事監理

CASE 4 (BWTS) 機器装置+エンジニアリング+設置資材
(配管、艀装、電気関係) の供給+設置工事+工事監理



BWTSの既存船工事は限定された時間内に装置設置を含め、
配管・艀装・電装品の改造が必要な複雑な工事です。
パナシアのレトロフィット専門チームは
工事の計画から完工まで、既存船工事全体を
一元化し、迅速かつ正確な対応でお客様のニーズに
お答えしております。

改造工事のフローチャート

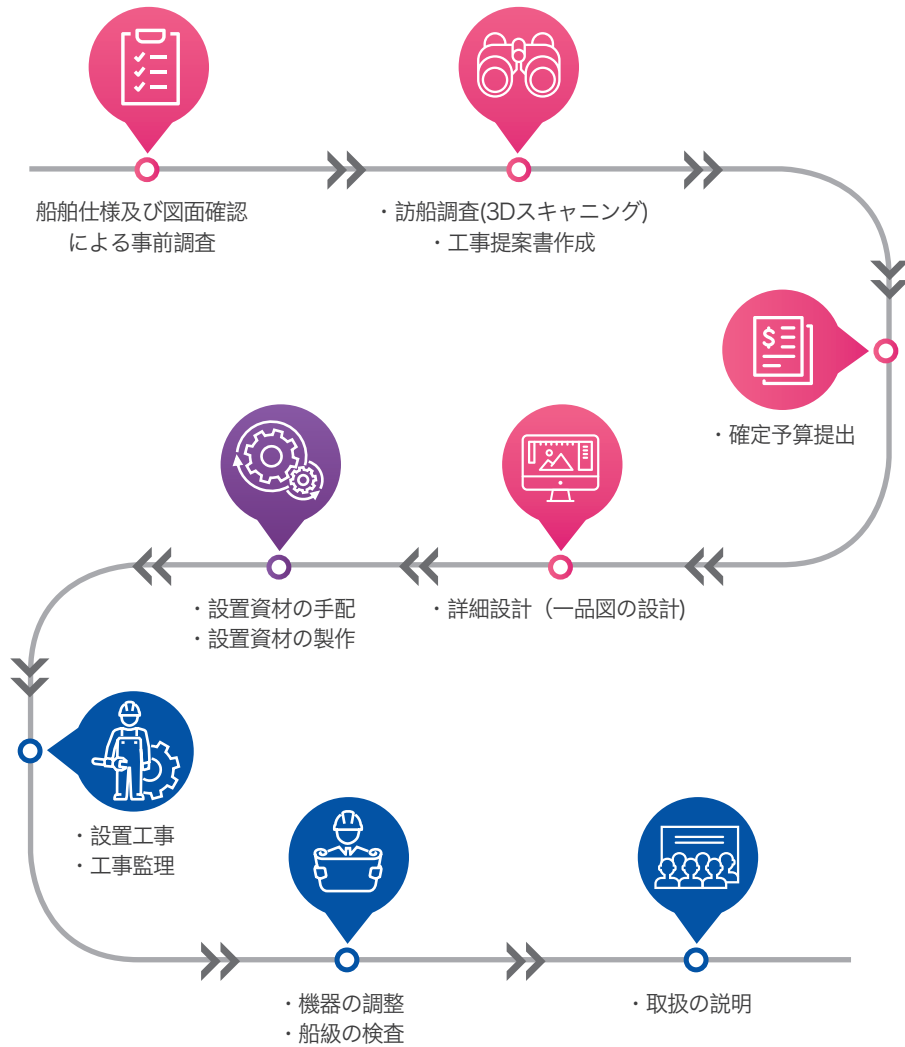

工事の所要期間

ドック工事又は岸壁工事の場合



航海中の工事の場合



※各船型や処理容量によって多少異なる場合があります。



Examination the drawing & Document

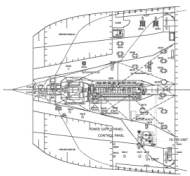

General Arrangement

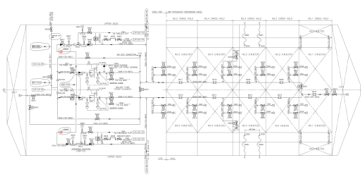

P & ID



Electric Load Analysis Drawing

Drawing List

1. General Arrangement	
2. Machinery Arrangement	To check available space for equipment
3. Electric Equipment Arrangement	
4. P & ID	To check how to modify the piping system
5. Electric Load Analysis Drawing	To check available power
6. Wiring diagram of Power System	To check the general specification of power system
7. Wiring Diagram of Control System	To check how to interface with existing automation system like GPS or AMS
8. Maker DWG of Group Starter Panel	To monitor of pump running status
9. Maker DWG of VRC System	To monitoring status of some valve related ballasting system

既存船設置工事を行うためには先ず、上記に記載されている図面リストの情報提供を必要とします。この事前準備を通じて、より正確な訪船調査が可能になります。



Pre-On-board survey



BWTS Passage check



Space check



Size check



Pump piping line check



Laser 3D scanning

訪船調査の段階では、BWTS機器装置を装着するスペースの確認を行い、3Dスキャンを通じて設置場所を撮影します。この作業により主要配管及び工事個所の確認を行い最適な 設置スペースを算出します。



Submit a proposal

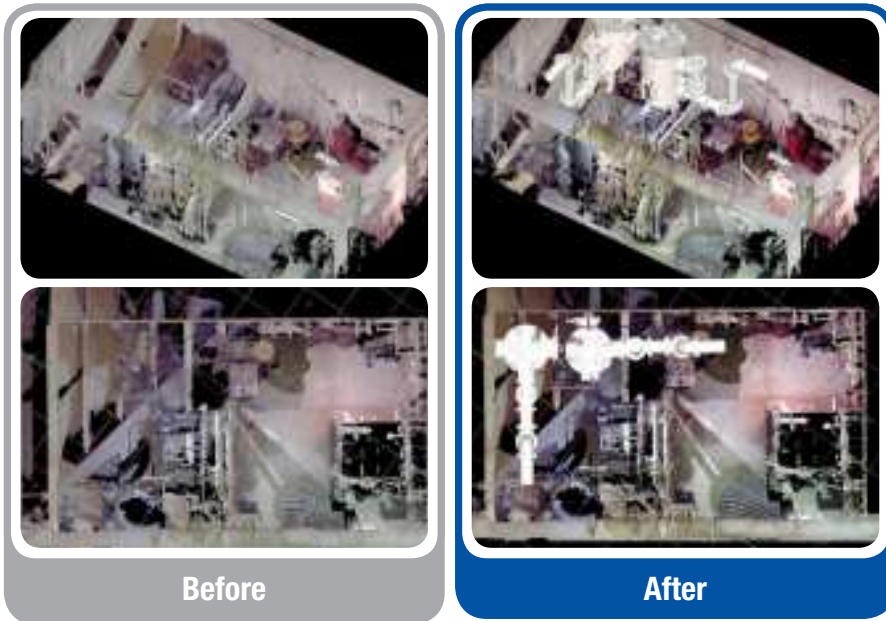

3Dスキャナーを通じて撮影したデータを活用しBWTS機器装置を装着した状態を3Dシュミレーションで提供します。
このデータにより、設置前と設置後の比較をすることができ、正確な設置費用や工事計画の算出が可能になります。



On-board survey

BWTS設置工事の契約後、詳細設計のため、データ分析を行い機器装置の設置場所及び配管などの艤装品の設置経路を決定します。
3Dスキャニングを実施し、機器に関連する電源供給ラインの確認、AMS、GPS等の船舶に既存設置されているシステムとの連動方法の分析を行います。
船舶から撮影したスキャンデータを逆設計して、3D図面としてモデリングします。
これにより、正確な配管設計が可能になります。

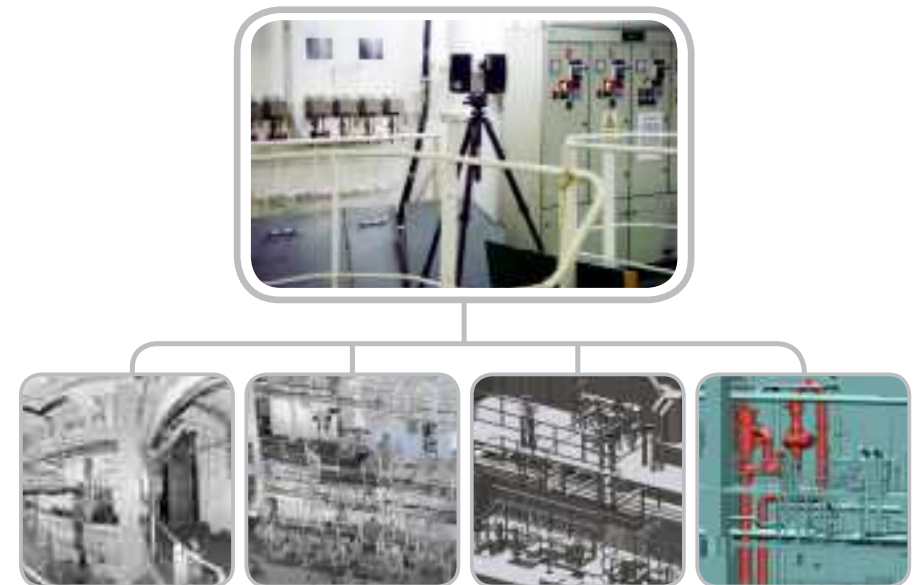



Installation Drawing

精密な3Dスキャンニングデータに基づいて、詳細設置図面を作成します。ISO、Section、Elev等の図面を提供することですべての工事業者が図面を理解しやすくするために各部品番号と組立順序が記載されており、より円滑な改造工事をサポートします。

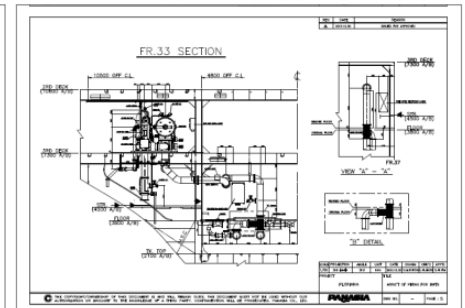
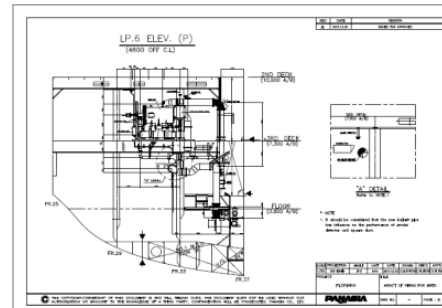
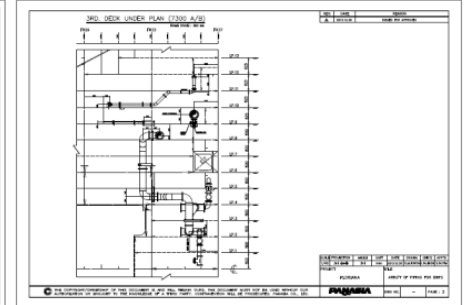
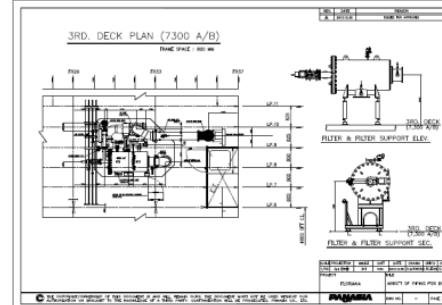
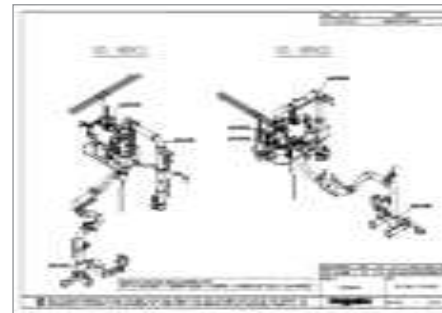
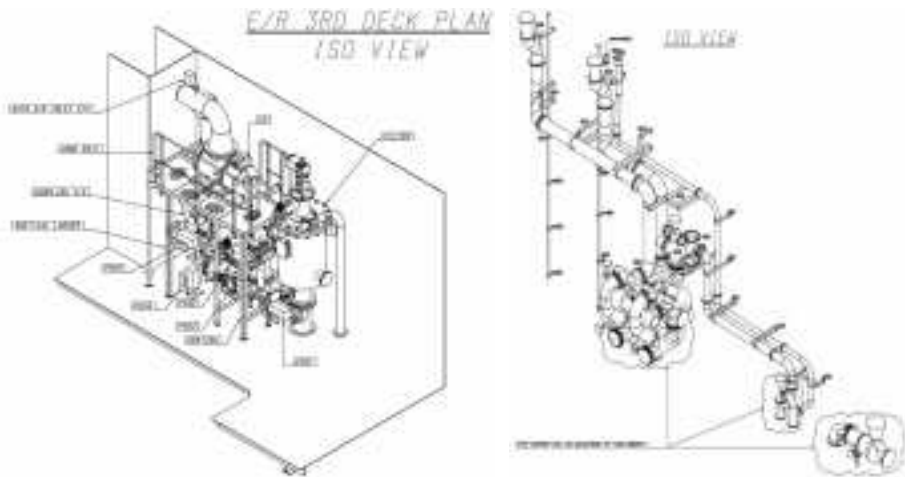

Engineering

Service

Pre-Engineering

Detail Engineering

Project Management

Supervision

パナシアから派遣される工事管理者は、船主監督、修理造船所との十分なコミュニケーションを通じて、日程内に完工できるようにサポートします。

You have successfully complete the retrofit installation through the supervision for BWTS



Engineering

Service

Pre-Engineering

Detail Engineering

Project Management

Supervision



Step 1

工事概要説明と打合せ



Step 3

各種設置工事の立会
現場での図面修正対応



Step 2

機器装置と設置資材確認



Step 4

各種インターフェイス
改造確認





既存船改造工事の 最高のパートナーに なります。

パナシアの優れた技術コンサルティングによって、船舶の構造に応じた空間の効率的な活用を行います。また、多様な船種・設置環境に対応できる実績を保有しております。

その技術経験を活かし、お客様に最適のソリューションを提供する最高のパートナーにして頂くことを目指しています。

- Dry Docking
- On Voyage
- Berthing
- Engine Room
- Pump Room (Tanker)
- On Deck
- Machinery Room

ASPHALT SEMINOLE



Ship owner	SARGEANT MARINE (USA)
Ship type	Asphalt carrier
Shipyard	Sembangwang Shipyard (Singapore)
Treatment capacity	250m ³ /h x 1set
Period	Dec 2014

- On board survey
3D Laser Scanning
- Installation
- Commissioning
- Complete



Material consumption

ITEM	SPEC'	Q'TY (pcs)	WEIGHT (kg)
PIPE (MAIN LINE)	200A (8")	47	2,847
PIPE (DRAIN)	50A (2")	5	44
SEAT & SUPPORT	-	91	1,231
CABLE	-	540m	263

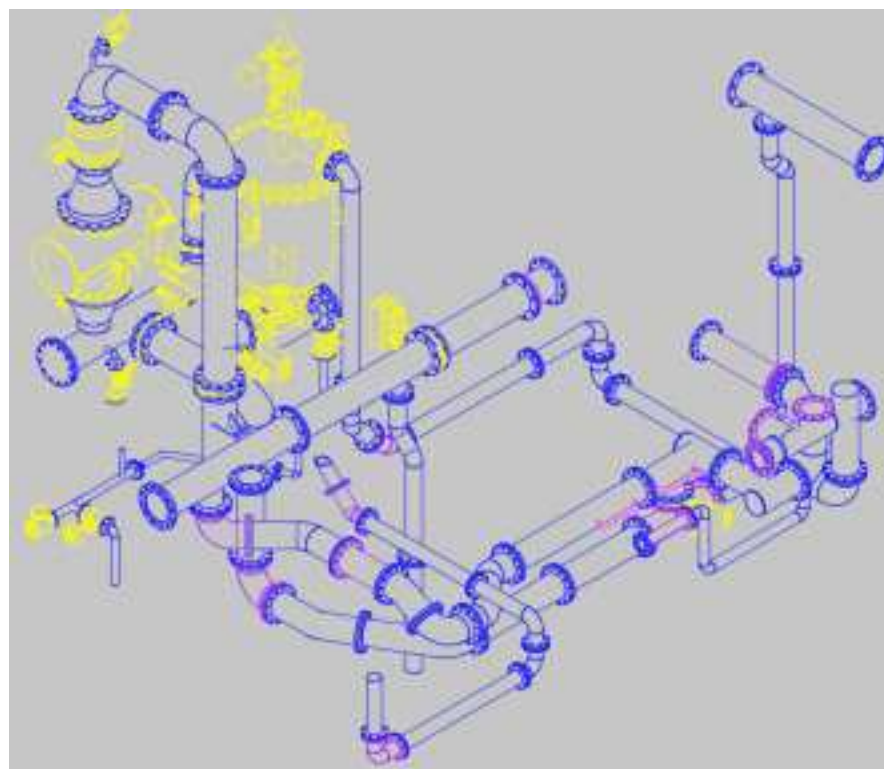

- Dry Docking
- On Voyage
- Berthing
- Engine Room
- Pump Room (Tanker)
- On Deck
- Machinery Room

MV LAVAUX



Ship owner	SUISSE ATLANTIQUE S.A (Switzerland)
Ship type	38K Bulk carrier
Shipyard	Quindao Beihai Shipyard (China)
Treatment capacity	1,500m ³ /h x 1set
Period	May 2015

- On board survey
3D Laser Scanning
- Installation
- Commissioning
- Complete



Material consumption

ITEM	SPEC'	Q'TY (pcs)	WEIGHT (kg)
PIPE (MAIN LINE)	450A (18")	74	7,715
PIPE (DRAIN)	50A (2")	38	651
SEAT & SUPPORT	-	48	1,792
CABLE	-	2,676m	1,858

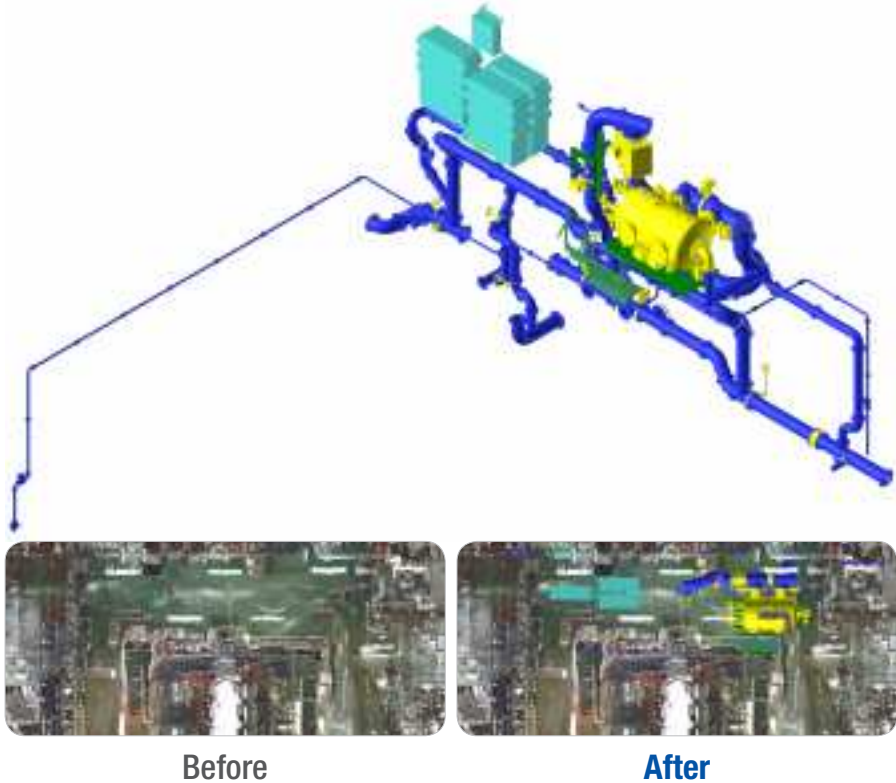

- Dry Docking
- On Voyage
- Berthing
- Engine Room
- Pump Room (Tanker)
- On Deck
- Machinery Room

GAS VISION



Ship owner	KSS SHIPPING (Korea)
Ship type	50K LPG TANKER
Shipyard	MMHE (MALAYSIA)
Treatment capacity	1,500m ³ /h x 1set
Period	FEB 2012

- On board survey
3D Laser Scanning
- Installation
- Commissioning
- Complete



Material consumption

ITEM	SPEC'	Q'TY (pcs)	WEIGHT (kg)
PIPE (MAIN LINE)	400A (16")	56	6,331
PIPE (DRAIN)	40A (1 1/2")	63	339
SEAT & SUPPORT	-	68	2,814
CABLE	-	1,634m	1,121

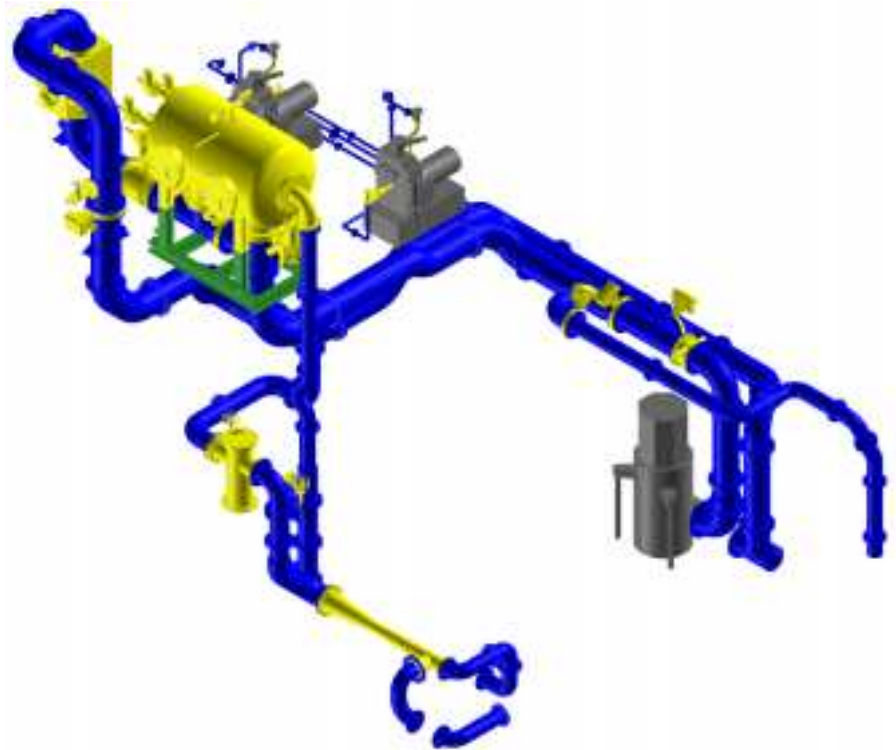

Dry Docking

On Voyage

Berthing

Engine Room

Pump Room (Tanker)

On Deck

Machinery Room

GAS VISION Retrofit Project

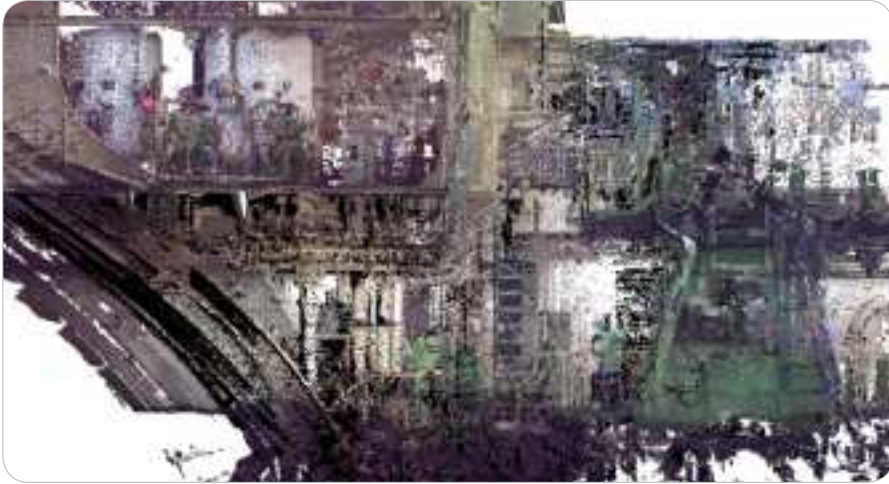

Before

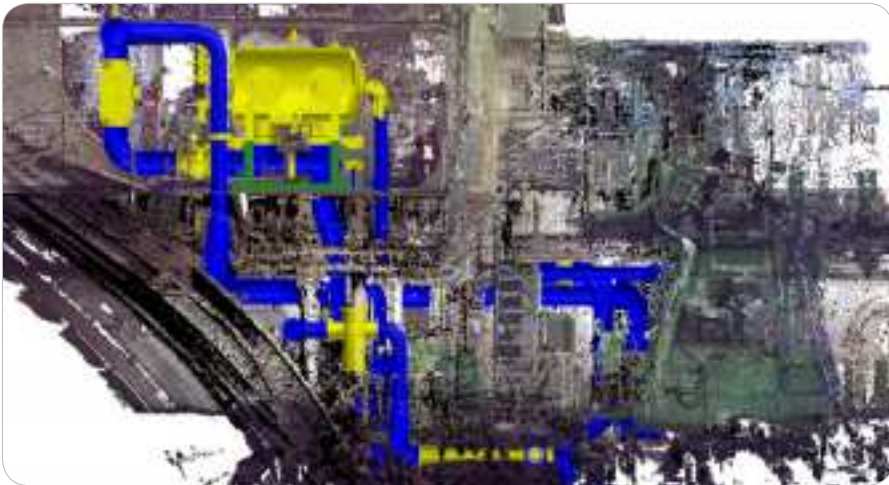

After



Before



After



Before

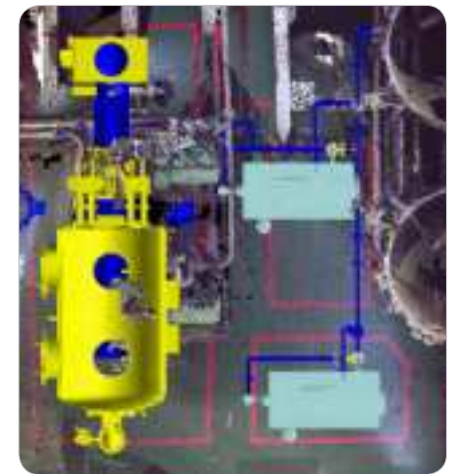

After

Dry Docking
On Voyage
Berthing

Engine Room
Pump Room (Tanker)
On Deck
Machinery Room

Engine Room & Pump Room Retrofit Project

Ship owner	Japanese owner
Ship type	50K Product / Chemical Tanker
Shipyard	Singapore
Treatment capacity	2,000m ³ /h (EX) x 1set + 350m ³ /h x 1set
Period	Jan 2016

On board survey
3D Laser Scanning
Installation
Commissioning
Complete



Material consumption

ITEM	Pump Room			Pump Room		
	SPEC'	Q'TY (pcs)	WEIGHT (kg)	SPEC'	Q'TY (pcs)	WEIGHT (kg)
PIPE (MAIN LINE)	450A (18")	60	8,098	250A (10")	43	2,380
PIPE (DRAIN)	40A (1 1/2")	21	92	40A (1 1/2")	11	191
SEAT & SUPPORT	-	69	1,666	-	29	455
CABLE	-	3,468m	1728	-	769m	328



Before



After



Before



After

Dry Docking
On Voyage
Berthing

Engine Room
Pump Room (Tanker)
On Deck
Machinery Room

On Deck type Retrofit Project

Ship owner	Japanese owner
Ship type	50K Product / Chemical Tanker
Shipyard	China
Treatment capacity	1,500m ³ /h (EX) x 1set + 250m ³ /h x 1set
Period	April 2016



Material consumption

ITEM	Upper Deck			Engine Room		
	SPEC'	Q'TY (pcs)	WEIGHT (kg)	SPEC'	Q'TY (pcs)	WEIGHT (kg)
PIPE (MAIN LINE)	300A (12")	255	26,301	200A (8")	52	3,340
PIPE (DRAIN)	-	-	-	25A (1")	14	40
SEAT & SUPPORT	-	141	3,149.6	-	58	652
CABLE	-	2,272m	1,221	-	917m	351



Before

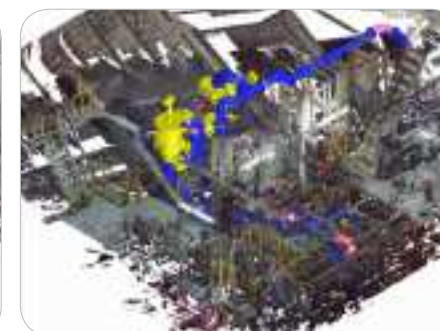

After



Before

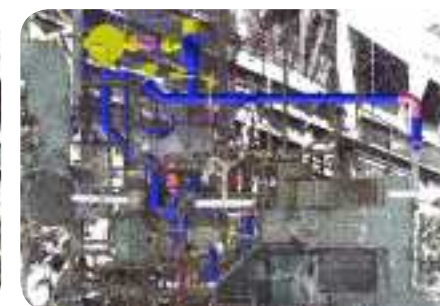

After

- Dry Docking
- On Voyage
- Berthing
- Engine Room
- Pump Room (Tanker)
- On Deck
- Machinery Room

ARAON



Ship owner	Korea Polar Research Institute (Korea)
Ship type	Ice breaking research vessel
Shipyard	Yeosu Haeyang (Korea)
Treatment capacity	150m ³ /h x 2sets
Period	June 2015

- On board survey
3D Laser Scanning
- Installation
- Commissioning
- Complete

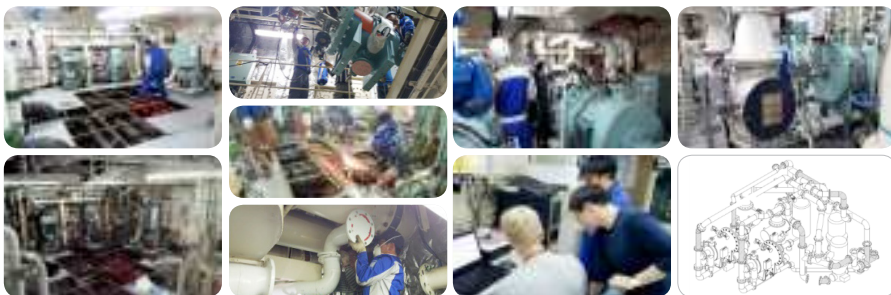

Material consumption

ITEM	SPEC'	Q'TY (pcs)	WEIGHT (kg)
PIPE (MAIN LINE)	150A (4")	53	2,599
PIPE (DRAIN)	40A (1 1/2")	13	316
SEAT & SUPPORT	-	19	285
CABLE	-	1,570m	561

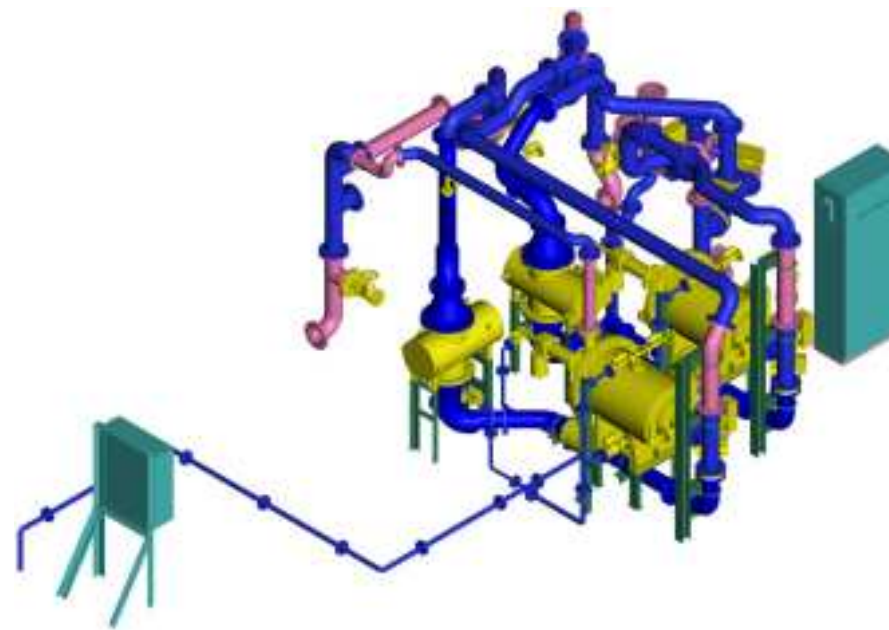

Dry Docking

On Voyage

Berthing

Engine Room

Pump Room (Tanker)

On Deck

Machinery Room

ARAON Retrofit Project

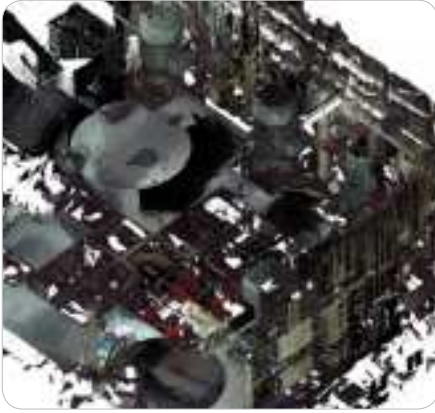

Before

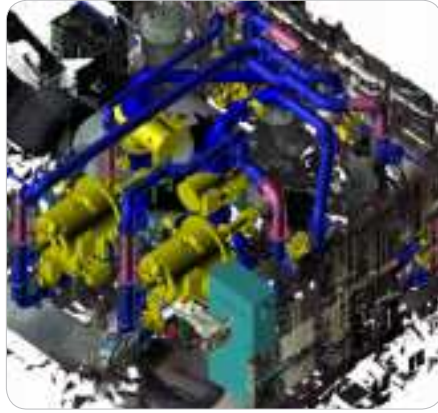

After



Before

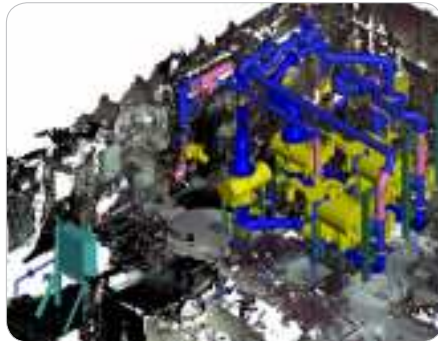

After



Before

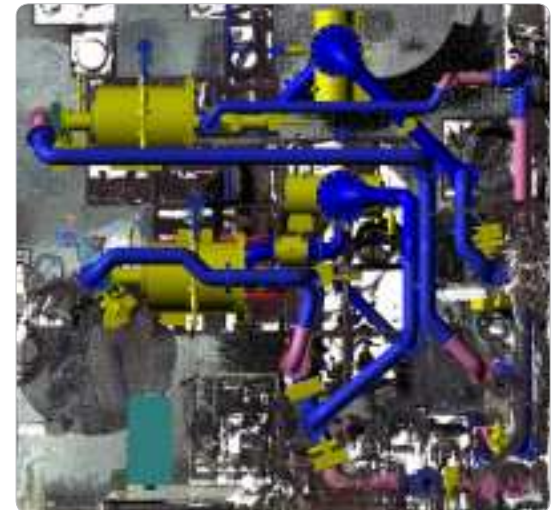

After

- Dry Docking
- On Voyage**
- Berthing
- Engine Room
- Pump Room (Tanker)
- On Deck
- Machinery Room

MV FLORIANA



Ship owner	TRANS SHIP (Ukraina)
Ship type	34K Bulk carrier
Treatment capacity	700m³/h x 1set
Period	June - July 2014

- On board survey
3D Laser Scanning
- Installation
- Commissioning
- Complete



Material consumption

ITEM	SPEC'	Q'TY (pcs)	WEIGHT (kg)
PIPE (MAIN LINE)	300A (12")	36	3,687
PIPE (DRAIN)	40A (1 1/2")	13	70
SEAT & SUPPORT	-	74	827
CABLE	-	1,755m	679

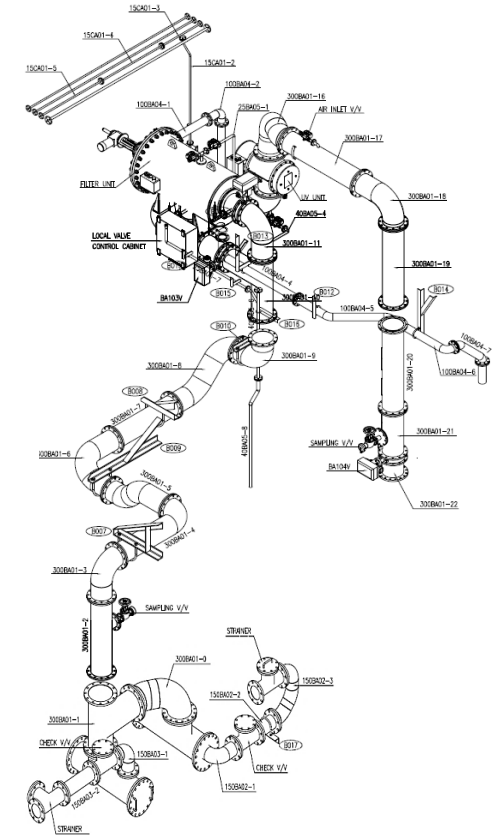

- Dry Docking
- On Voyage
- Berthing
- Engine Room
- Pump Room (Tanker)
- On Deck
- Machinery Room

WOORYANG BANDERS



Ship owner	WOORYANG SHIPPING(Korea)
Ship type	73K Bulk carrier
Treatment capacity	1000m ³ /h x 2sets
Period	July – September, 2016



Material consumption

ITEM	SPEC'	Q'TY (pcs)	WEIGHT (kg)
PIPE (MAIN LINE)	350A	89	7,921
PIPE (DRAIN)	40A	31	216
SEAT & SUPPORT	-	214	4,719
CABLE	-	3,194m	1,235

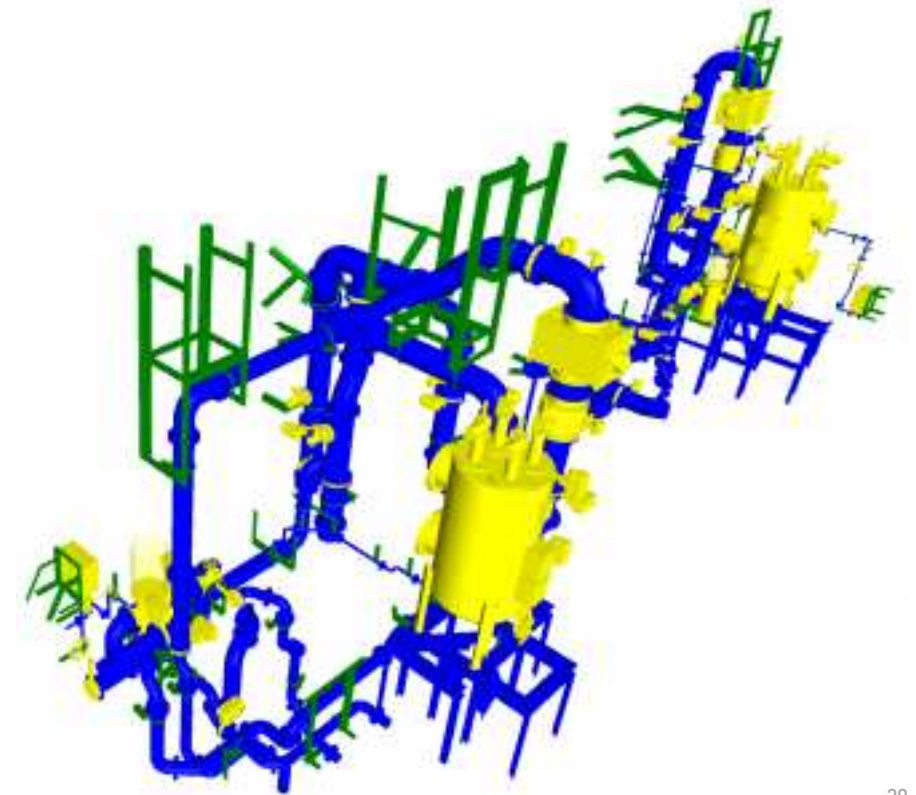

Dry Docking

On Voyage

Berthing

Engine Room

Pump Room (Tanker)

On Deck

Machinery Room

WOoyang BANDERS Retrofit Project



Before



After



Before

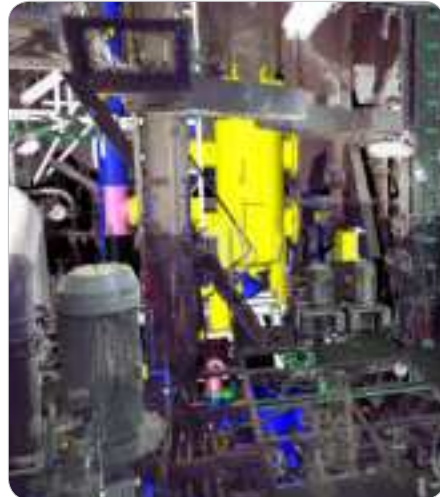

After



Before

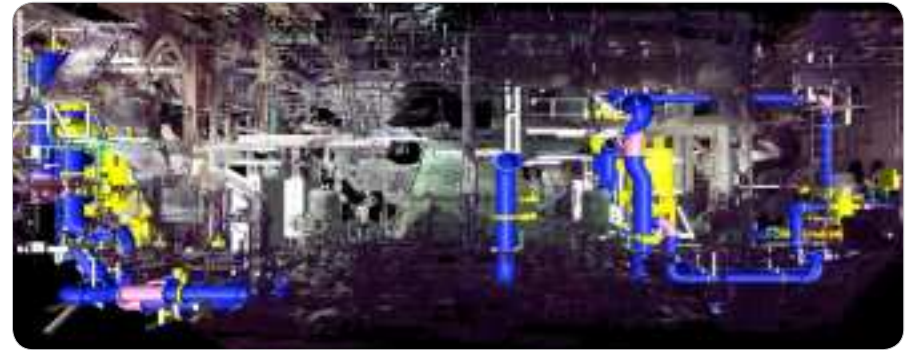

After

- Dry Docking
- On Voyage
- Berthing
- Engine Room
- Pump Room (Tanker)
- On Deck
- Machinery Room

ORANGE WAVE



Ship owner	ATLANSHIP (Switzerland)
Ship type	Fruit Juice Tanker
Treatment capacity	250m ³ /h x 1set
Period	Feb – March, 2015

- On board survey
3D Laser Scanning
- Installation
- Commissioning
- Complete



Material consumption

ITEM	SPEC'	Q'TY (pcs)	WEIGHT (kg)
PIPE (MAIN LINE)	250A (10")	43	1,719
PIPE (DRAIN)	40A (1 1/2")	12	68
SEAT & SUPPORT	-	50	615
CABLE	-	2,220m	782

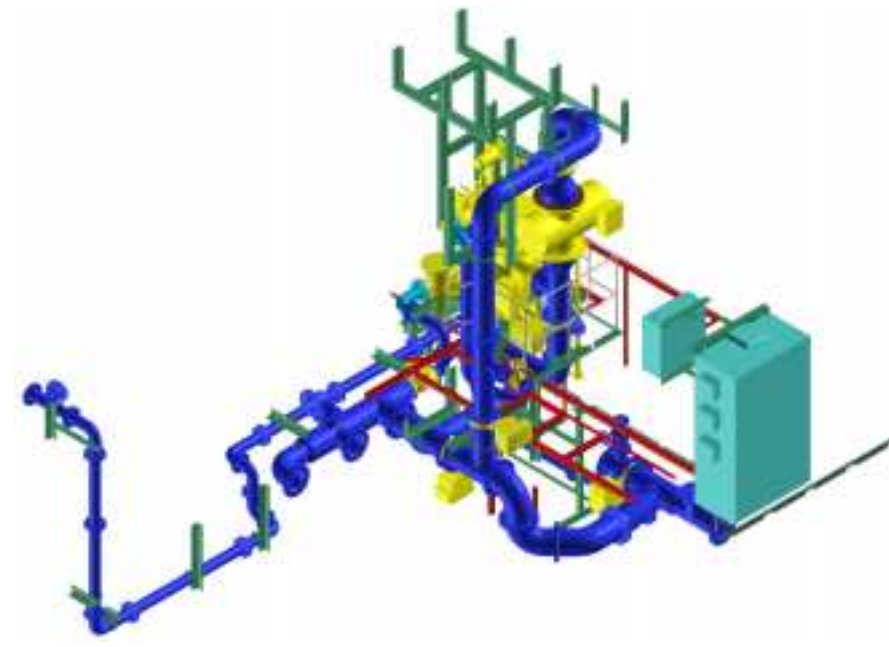

Dry Docking

On Voyage

Berthing

Engine Room

Pump Room (Tanker)

On Deck

Machinery Room

ORANGE WAVE Retrofit Project



Before



Before

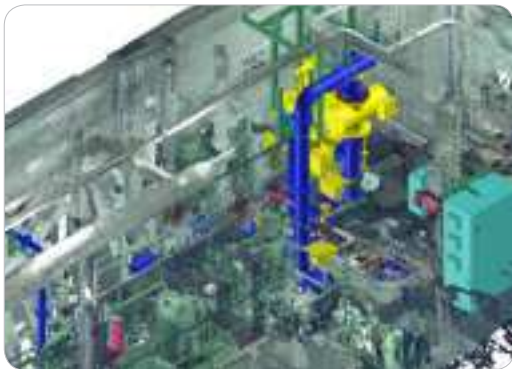

After



After



Before



After

Worldwide Service Network

Effective Follow-up Service, Prompt Action for Spare Parts.

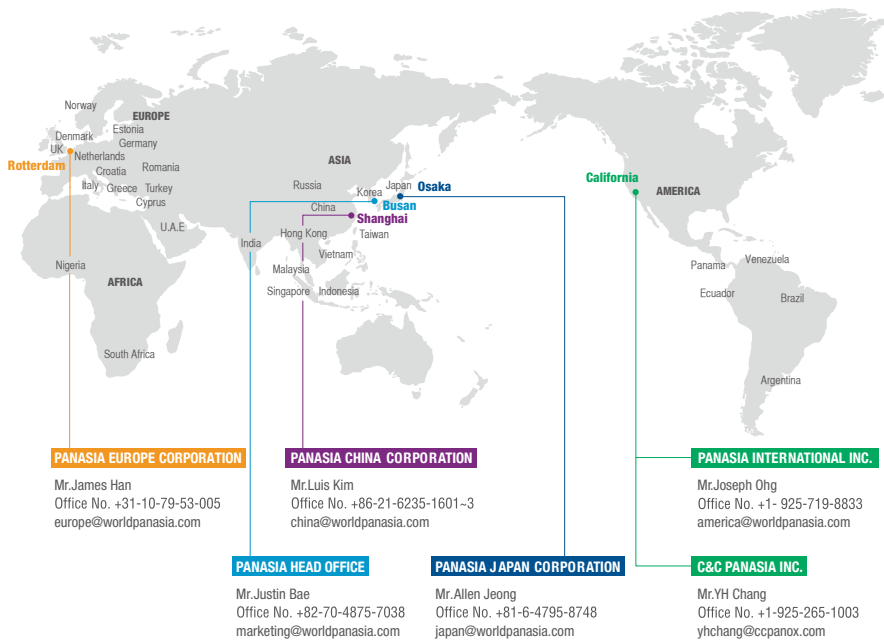



HEAD OFFICE & FACTORY	46744, 55, Mieumsandan 3-ro, Gangseo-gu, Busan, Korea TEL: +82-51-831-1010 FAX: +82-51-831-1399 www.worldpanasia.com E-mail: panasia@worldpanasia.com
MARKETING	TEL: +82-70-4875-7038 E-mail: marketing@worldpanasia.com
SERVICE	BWTS TEL: +82-70-4875-7147 E-mail: bwts_service@worldpanasia.com TLGS TEL: +82-70-4875-7148 E-mail: tlgs_service@worldpanasia.com



お問合せ先	株式会社パナシアジャパン 大阪市北区梅田1-1-3大阪駅前第3ビル6階 TEL : 06-4795-8748~9 FAX : 06-6453-8748 E-mail : japan@worldpanasia.com
--------------	--
